

ÄM-Nr. / ECN	26739000		Maßstab / Scale	Status	Grohe AG Industriepark Edelburg D-58675 Hemer Tel. 02372 / 93-0	
Datum / Date	20. 4.2024		1:4			
Verantw./ Respons.	Matsumoto			Copyright reserved		
Geprüft / Approved	Nanakarage					
Benennung / Title	RSH F-series Rohbaukasten klein RSH ROUGH-IN SMALL CEILING SHOWER				Zeichnung Nr. / Drawing No.: 2673900J	
Prod.-No. + Variants:	2673900J				TPI-Referenz / TPI-Reference: m2673900J_3a	

【レイアウト参考図 1】

＜レイアウト＞

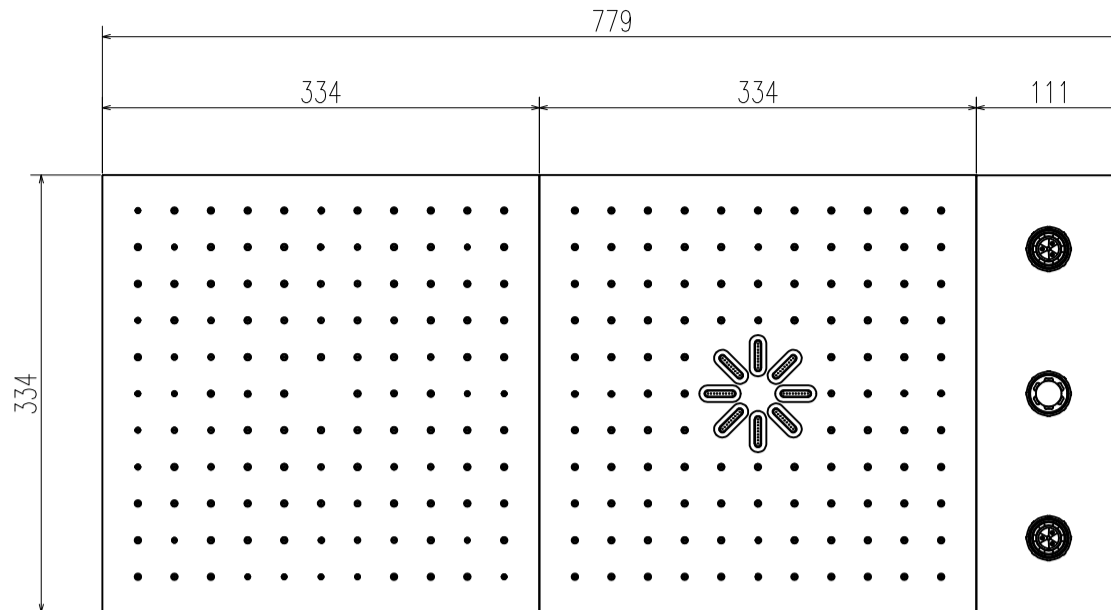

＜天井設置イメージ＞

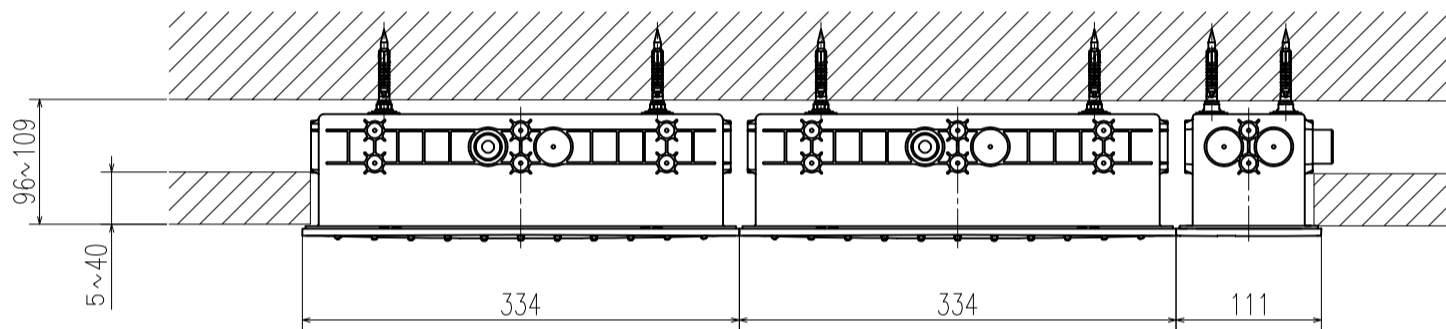

＜取付け穴配置図＞

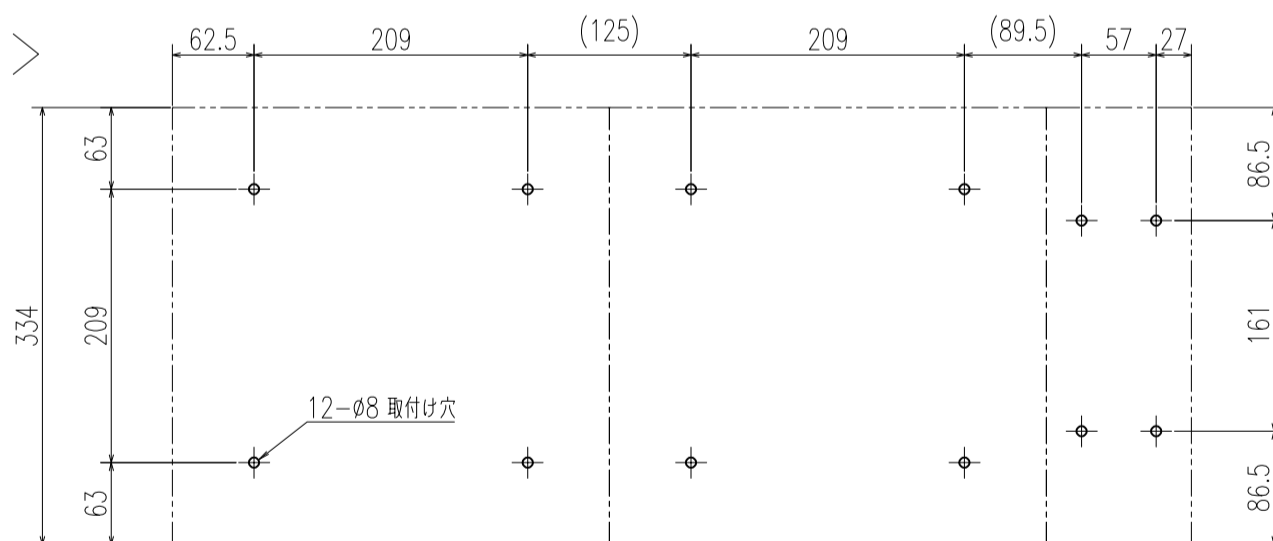

注記 1. () 内の寸法は参考寸法です。本体を連結の際に誤差が生じる可能性があります。
本体連結後に寸法を計測して調整してください。

ÄM-Nr. / ECN		Maßstab / Scale	Status	Grohe AG Industriepark Edelburg D-58675 Hemer Tel. 02372 / 93-0	
Datum / Date	24. 9.2024				
Verantw. / Respons.	Sekine		Copyright reserved		
Geprüft / Approved	Matsumoto				
Benennung / Title	Rainshower Aqua			Zeichnung Nr. / Drawing No.: -	
Prod.-No. + Variants:	レイアウト参考図 1			TPI-Referenz / TPI-Reference: -	

【レイアウト参考図2】

＜レイアウト＞

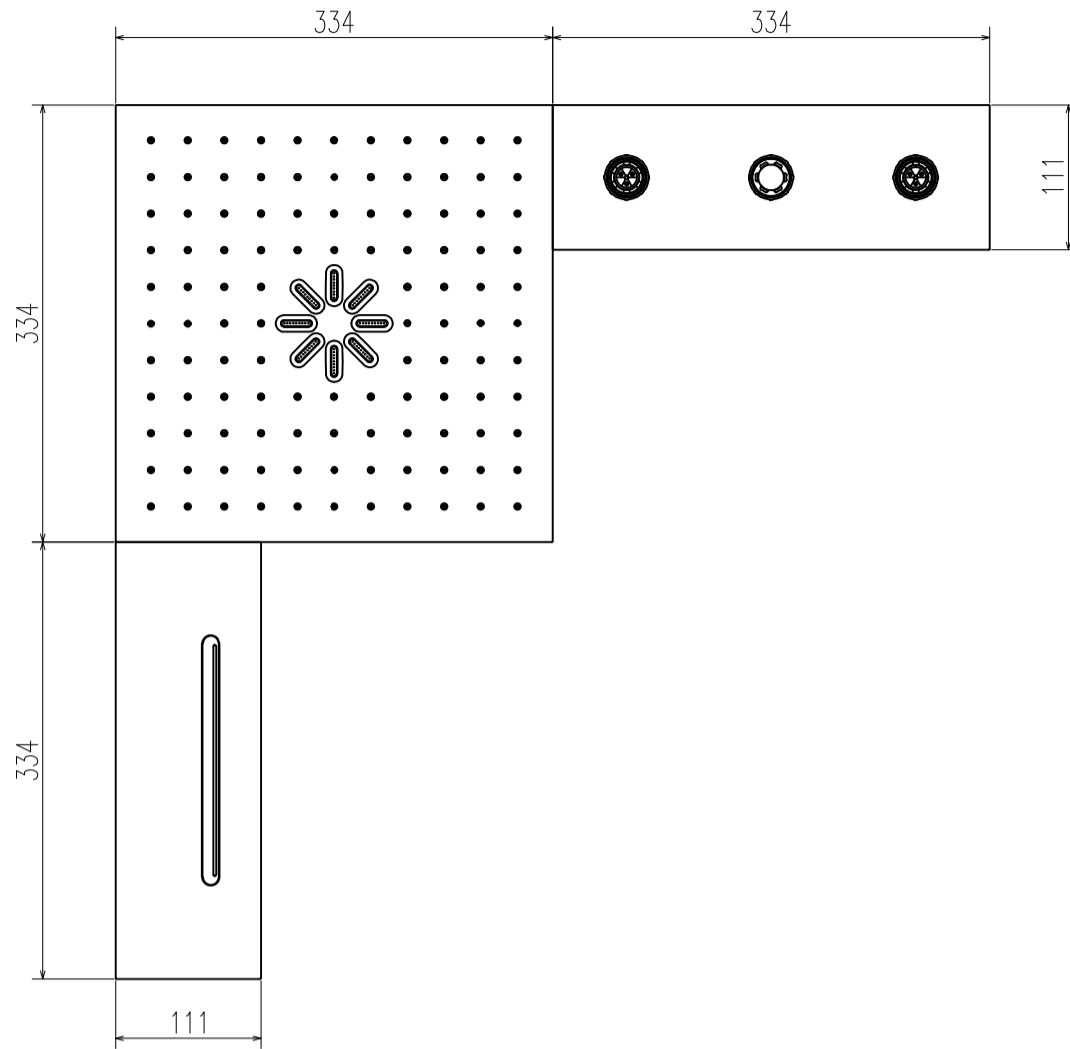

＜天井設置イメージ＞

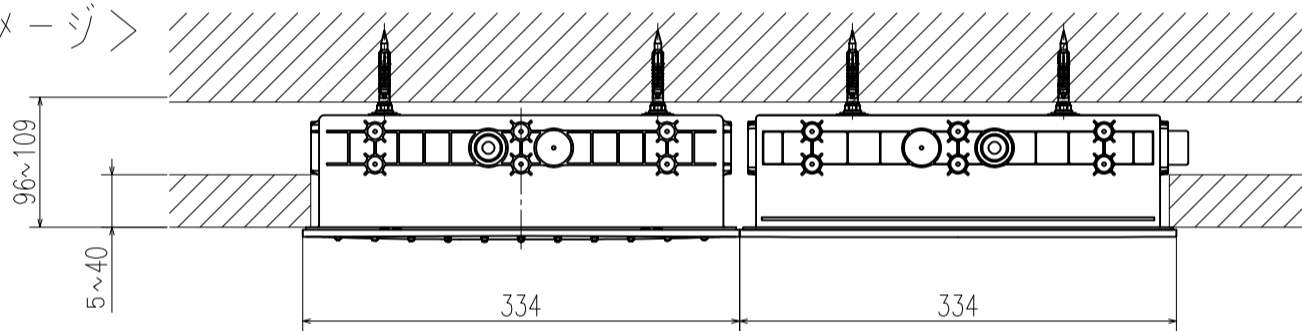

＜取付け穴配置図＞

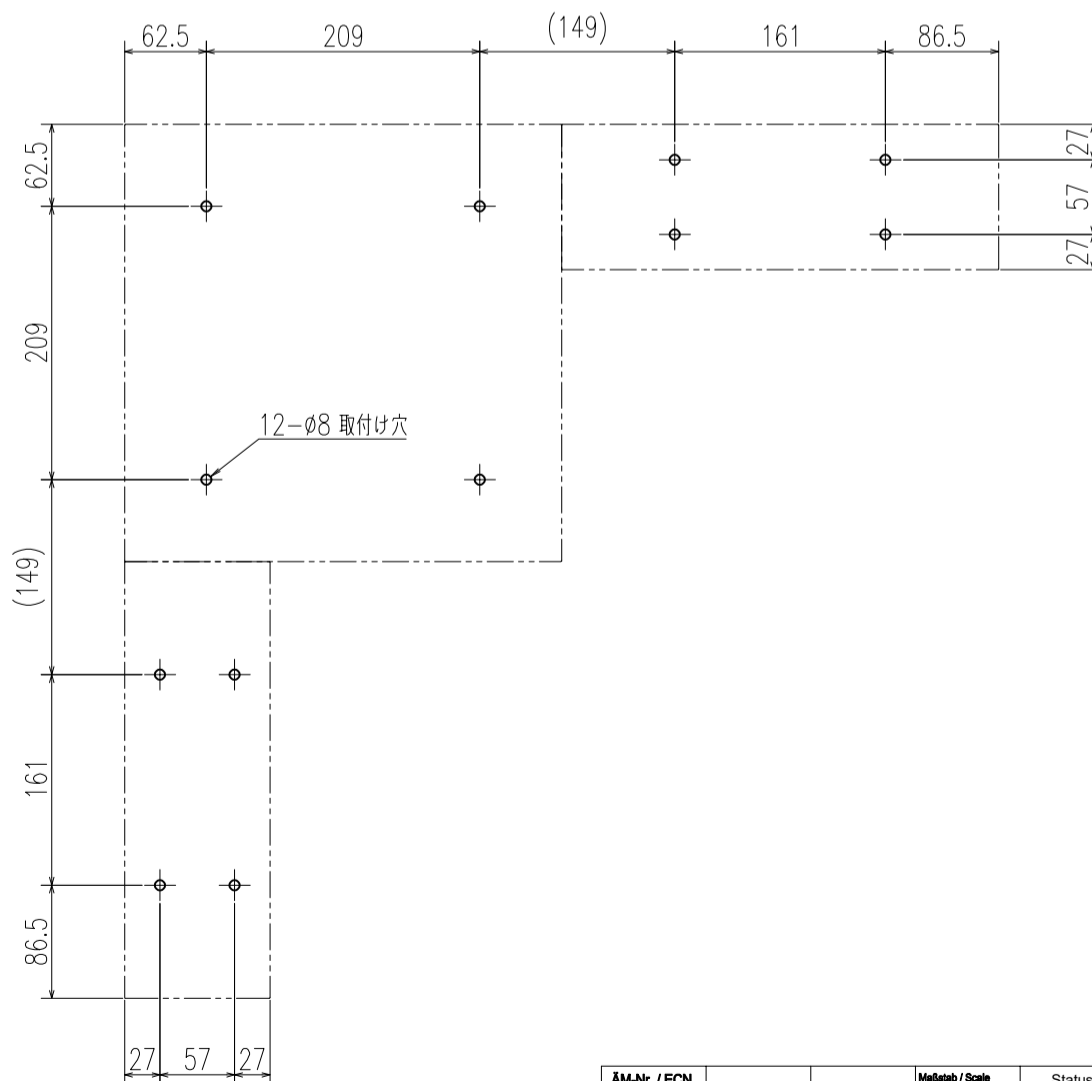

注記 1. () 内の寸法は参考寸法です。本体を連結の際に誤差が生じる可能性があります。
 本体連結後に寸法を計測して調整してください。

AM-Nr. / ECN		Maßstab / Scale	Status	Grohe AG Industriepark Edelburg D-58675 Hemer Tel. 02372 / 93-0	
Datum / Date	24. 9.2024				
Verantw. / Respons.	Sekine		Copyright reserved		
Geprüft / Approved	Matsumoto				
Benennung / Title	Rainshower Aqua			Zeichnung Nr. / Drawing No.: -	
Prod.-No. + Variants:	レイアウト参考図2			TPI-Referenz / TPI-Reference: -	

【レイアウト参考図3】

＜レイアウト＞

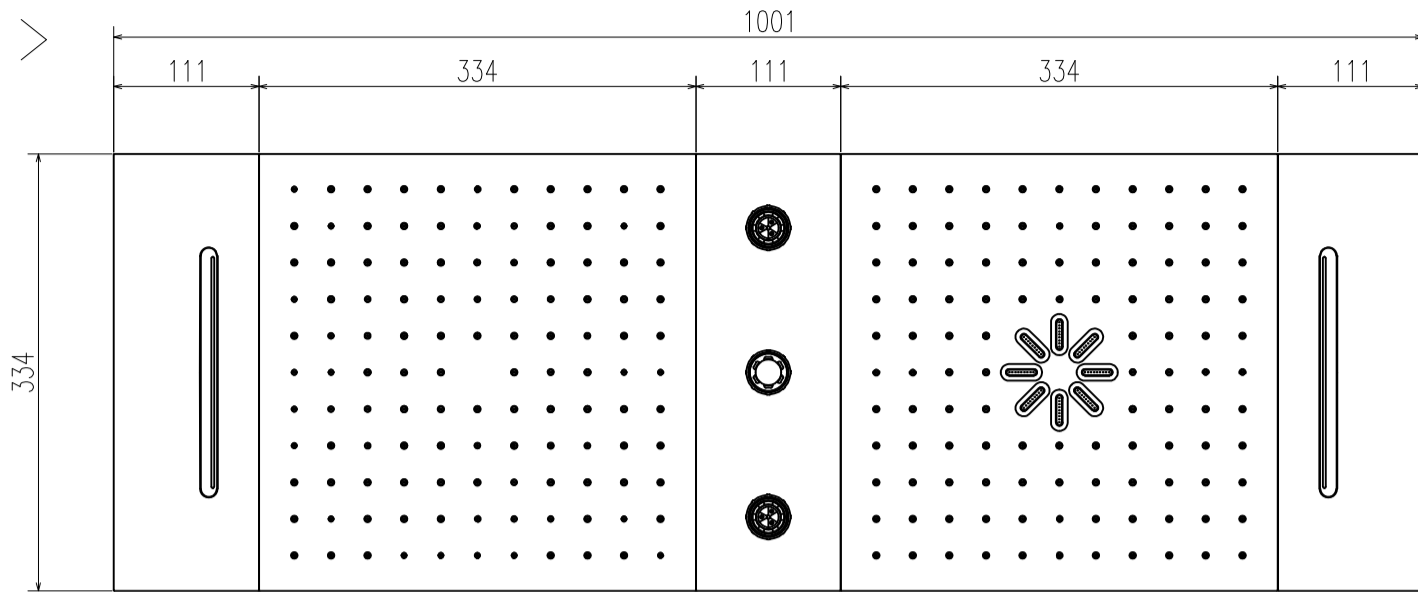

＜天井設置イメージ＞

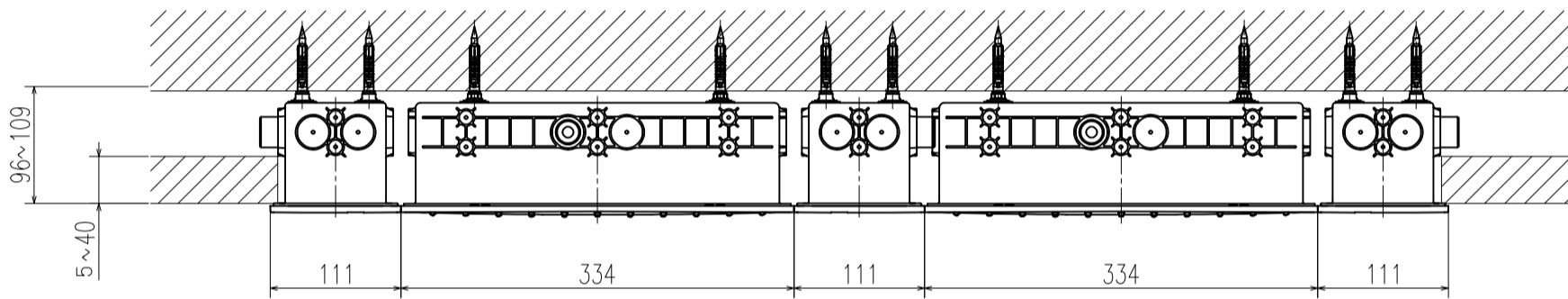

＜取付け穴配置図＞

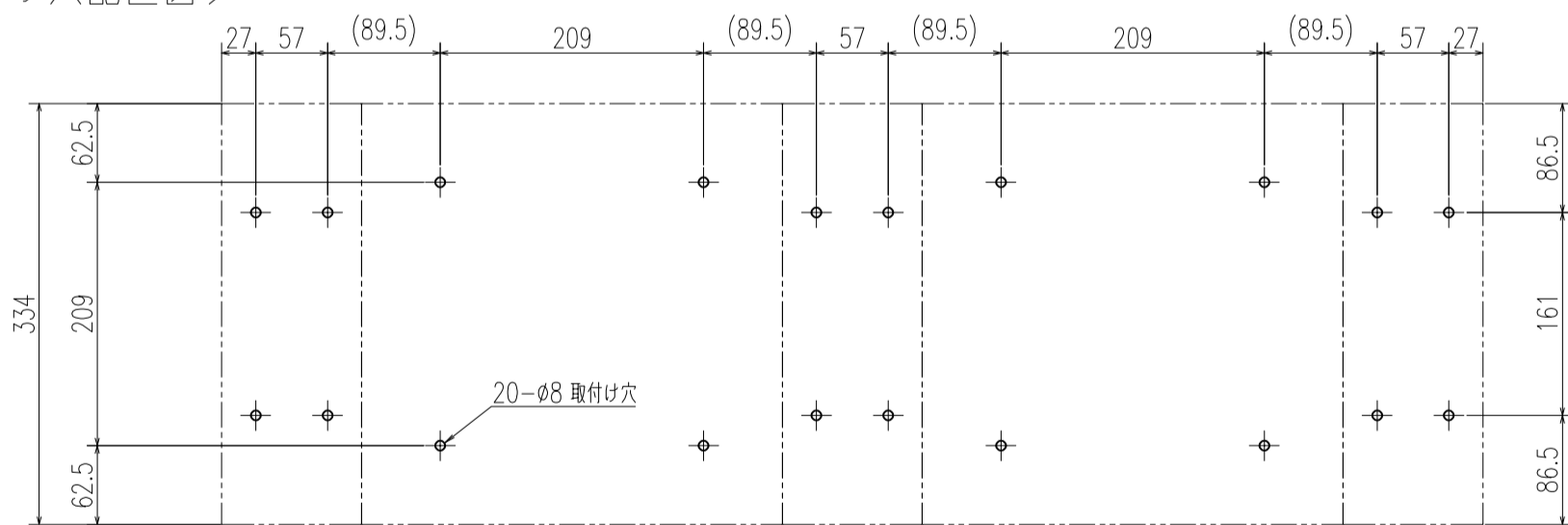

注記 1. () 内の寸法は参考寸法です。本体を連結の際に誤差が生じる可能性があります。
 本体連結後に寸法を計測して調整してください。

AM-Nr. / ECN		Maßstab / Scale	Status	Grohe AG Industriepark Edelburg D-58675 Hemer Tel. 02372 / 93-0 
Datum / Date	24. 9.2024			
Verantw. / Respons.	Sekine		Copyright reserved	
Geprüft / Approved	Matsumoto			
Benennung / Title	Rainshower Aqua			Zeichnung Nr. / Drawing No.:
Prod.-No. + Variants:	レイアウト参考図3			TPI-Referenz / TPI-Reference: